

# BRB13N50

Rev.A Nov.-2016

## 描述 / Descriptions

TO-263 塑封封装 N 沟道 MOS 场效应管。N-CHANNEL MOSFET in a TO-263Plastic Package.

## 特征 / Features

低的门槛电压、反向传输电容小、开关速度快。

Low gate charge, Low Crss , Fast switching.

## 用途 / Applications

用于小型化高效率的开关电源的 AC/DC 功率转换。

It is very suitable for various AC/DC power conversion in switching mode operation for system miniaturization and higher efficiency.

## 内部等效电路 / Equivalent Circuit

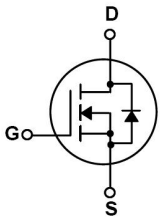

## 引脚排列 / Pinning



PIN1 : G

PIN 2,4 : D

PIN 3 : S

## 放大及印章代码 / $h_{FE}$ Classifications & Marking

见印章说明。 See Marking Instructions.

**极限参数 / Absolute Maximum Ratings(Ta=25°C)**

参数 Parameter	符号 Symbol	数值 Rating	单位 Unit
Drain-Source Voltage	$V_{DSS}$	500	V
Drain Current	$I_D(T_C=25^\circ C)$	13	A
Drain Current	$I_D(T_C=100^\circ C)$	8	A
Drain Current - Pulsed	$I_{DM}$	52	A
Gate-Source Voltage	$V_{GSS}$	$\pm 30$	V
Single Pulsed Avalanche Energy	$E_{AS}$	860	mJ
Repetitive Avalanche Energy	$E_{AR}$	19.5	mJ
Avalanche Current	$I_{AR}$	13	A
Power Dissipation	$P_D(T_C=25^\circ C)$	195	W
Operating and Storage Temperature Range	$T_J, T_{STG}$	-55 to 150	$^\circ C$

**电性能参数 / Electrical Characteristics(Ta=25°C)**

参数 Parameter	符号 Symbol	测试条件 Test Conditions	最小值 Min	典型值 Typ	最大值 Max	单位 Unit
Drain-Source Breakdown Voltage	$BV_{DSS}$	$V_{GS}=0V$ $I_D=250\mu A$	500			V
Zero Gate Voltage Drain Current	$I_{DSS}$	$V_{DS}=500V$ $V_{GS}=0V$			1.0	$\mu A$
		$V_{DS}=400V$ $T_C=125^\circ C$			10	$\mu A$
Gate-Body Leakage Current, Forward	$I_{GSS}$	$V_{GS}=\pm 30V$ $V_{DS}=0V$			$\pm 0.1$	$\mu A$
Gate Threshold Voltage	$V_{GS(th)}$	$V_{DS}=V_{GS}$ $I_D=250\mu A$	2.0		4.0	V
Static Drain-Source On-Resistance	$R_{DS(on)}$	$V_{GS}=10V$ $I_D=6.5A$		0.39	0.48	$\Omega$
Forward Transconductance	$g_{FS}$	$V_{DS}=40V$ $I_D=6.5A$		15		S
Drain-Source Diode Forward Voltage	$V_{SD}$	$V_{GS}=0V$ $I_S=13A$			1.4	V
Input Capacitance	$C_{iss}$	$V_{DS}=25V$ $V_{GS}=0V$ $f=1.0MHz$		1580	2055	pF
Output Capacitance	$C_{oss}$			180	235	pF
Reverse Transfer Capacitance	$C_{rss}$			20	25	pF
Turn-On Delay Time	$t_{d(on)}$	$V_{DD}=300V$ $I_D=13A$ $R_G=25\Omega$		25	60	ns
Turn-On Rise Time	$t_r$			100	210	ns
Turn-Off Delay Time	$t_{d(off)}$			130	270	ns
Turn-Off Fall Time	$t_f$			100	210	ns

**电参数曲线图 / Electrical Characteristic Curve**

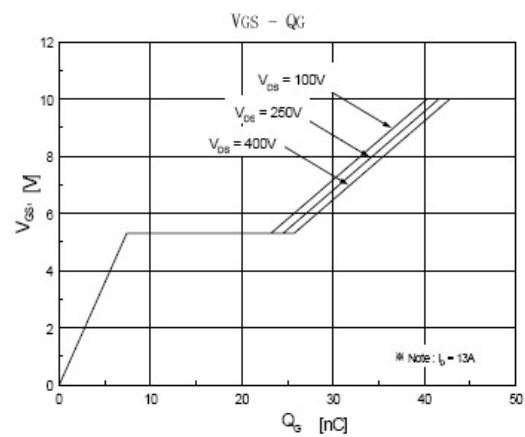
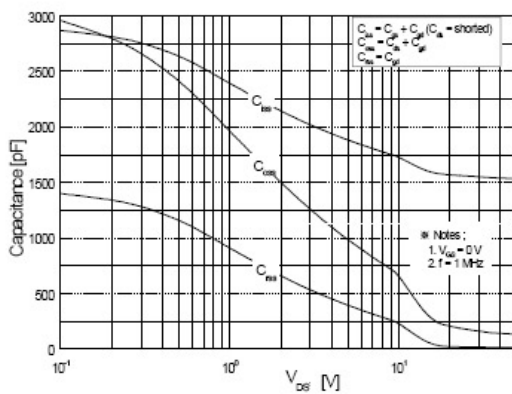
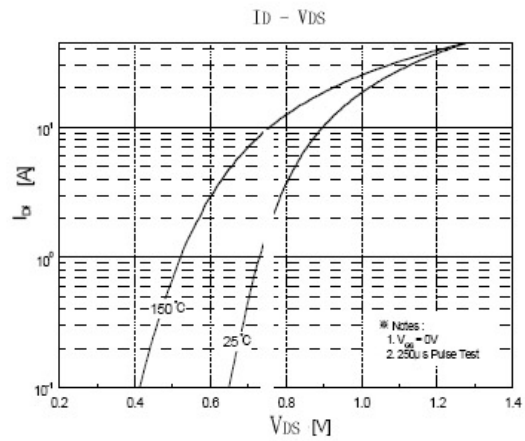
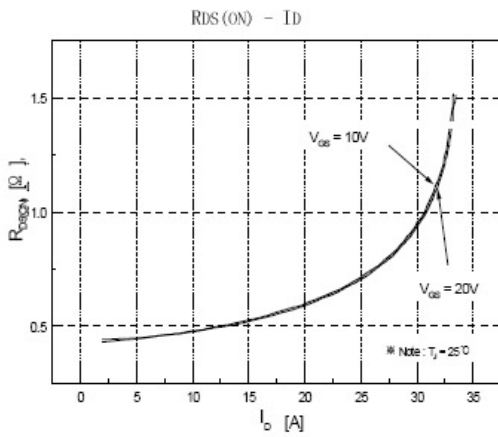
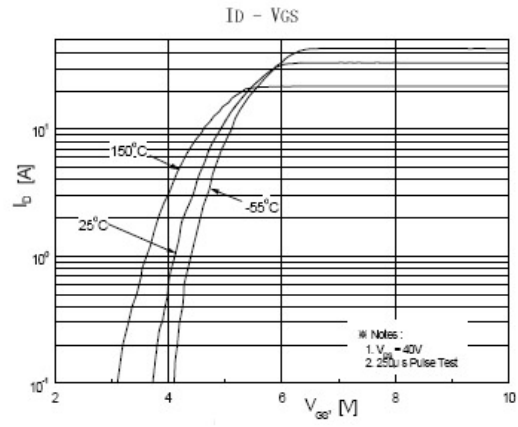
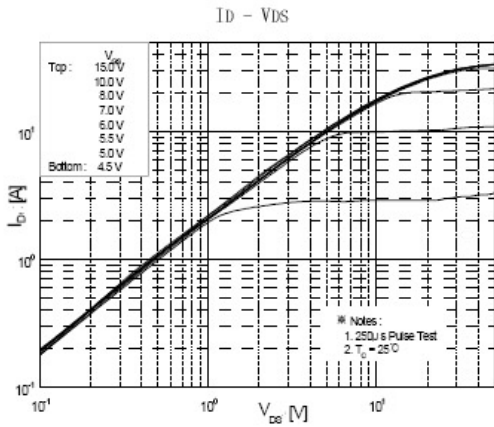

外形尺寸图 / Package Dimensions

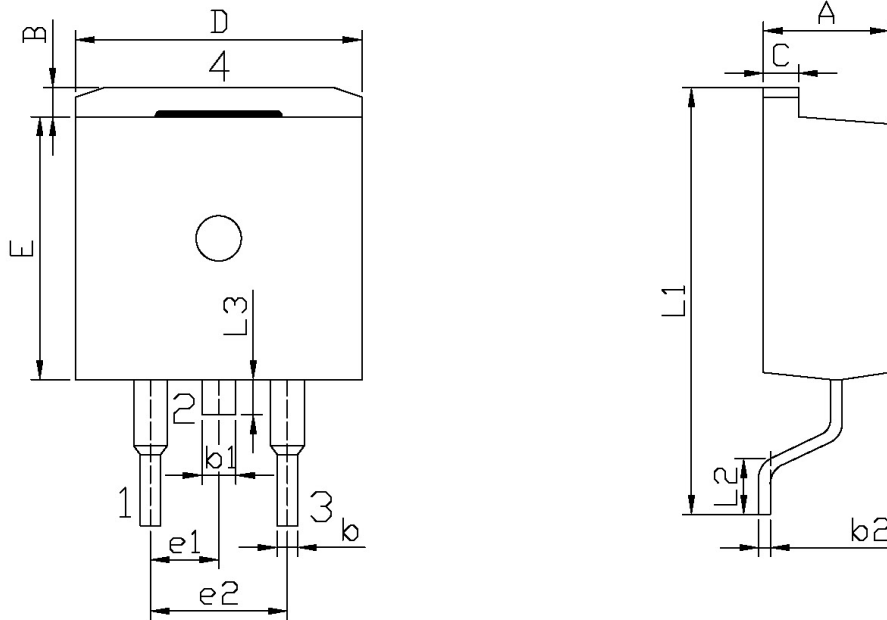

单位: mm

Symbol	Dimensions In Millimeters		Symbol	Dimensions In Millimeters	
	Min	Max		Min	Max
A	4.30	4.70	E	9.00	9.40
B	1.00	1.40	e1	2.34	2.74
b	0.70	0.90	e2	4.88	5.28
b1	1.15	1.35	L1	15.00	16.00
b2	0.40	0.60	L2	2.24	2.84
C	1.20	1.40	L3	1.20	1.60
D	9.80	10.20			

TO-263

印章说明 / Marking Instructions

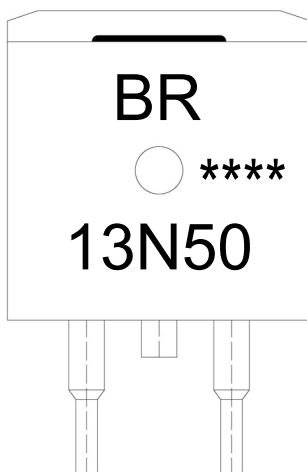

说明：

BR： 为公司代码

13N50： 为型号代码

\*\*\*\*： 为生产批号代码，随生产批号变化。

Note:

BR: Company Code

13N50: Product Type.

\*\*\*\*: Lot No. Code, code change with Lot No.

**回流焊温度曲线图(无铅) / Temperature Profile for IR Reflow Soldering(Pb-Free)**



说明：

- 1、预热温度 25~150°C，时间 60~90sec;
- 2、峰值温度 245±5°C，时间持续为 5±0.5sec;
- 3、焊接制程冷却速度为 2~10°C/sec.

Note:

- 1.Preheating:25~150°C, Time:60~90sec.
- 2.Peak Temp.:245±5°C, Duration:5±0.5sec.
3. Cooling Speed: 2~10°C/sec.

**耐焊接热试验条件 / Resistance to Soldering Heat Test Conditions**

温度：260±5°C      时间：10±1 sec.      Temp.:260±5°C      Time:10±1 sec

**包装规格 / Packaging SPEC.**

卷盘包装 / REEL

Package Type 封装形式	Units 包装数量					Dimension 包装尺寸 (unit: mm <sup>3</sup> )		
	Units/Reel 只/卷盘	Reels/Inner Box 卷盘/盒	Units/Inner Box 只/盒	Inner Boxes/Outer Box 盒/箱	Units/Outer Box 只/箱	Reel	Inner Box 盒	Outer Box 箱
TO-263	800	1	800	5	4,000	13" x24	360×360×50	385×257×392

套管包装 / TUBE

Package Type 封装形式	Units 包装数量					Dimension 包装尺寸 (unit: mm <sup>3</sup> )		
	Units/Tube 只/套管	Tubes/Inner Box 套管/盒	Units/Inner Box 只/盒	Inner Boxes/Outer Box 盒/箱	Units/Outer Box 只/箱	Tube 套管	Inner Box 盒	Outer Box 箱
TO-263	50	20	1,000	5	5,000	532×33×7.0	555×164×50	575×290×180

**使用说明 / Notices**