

描述 / Descriptions

TO-252 塑封封装电压调整器。Voltage Regulator in a TO-252 Plastic Package.

特征 / Features

三端稳压调整器，输出电流高达 1.0A,内设过热保护和短路限制，符合 AEC-Q100 标准高可靠性要求，无卤产品。

3-Terminal regulators ,output current up to 1.0A, internal thermal overload protection and short-circuit limiting, Qualified to AEC-Q100 Standards for High Reliability, HF Product.

用途 / Applications

电压调整器，满足汽车应用的严格要求。

Voltage Regulator, Meet the stringent requirements of automotive applications.

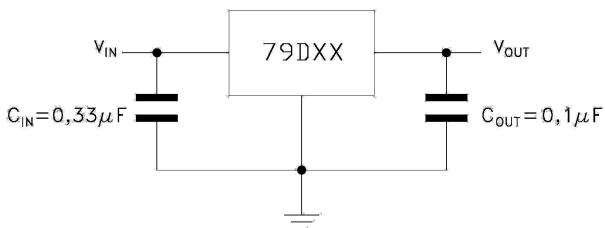
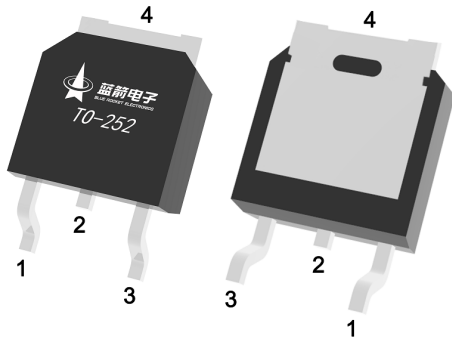
内部等效电路/应用电路 / Equivalent Circuit or Application Circuit**引脚排列 / Pinning**

PIN1 : GND

PIN 2、 4 : IN

PIN 3 : OUT

印章代码 / Marking

见印章说明。

See Marking Instructions.

极限参数 / Absolute Maximum Ratings(Ta=25°C)

参数 Parameter	符号 Symbol	数值 Rating	单位 Unit
Input Voltage Difference	V_i	-35	V
Junction-to-Ambient	$R_{\theta JA}$	65	°C/W
Junction-to-Case	$R_{\theta JC}$	5	°C/W
Operating Temperature Range	T_{OPR}	-40~125	°C
Storage temperature range	T_{stg}	-65~+150	°C

电性能参数 / Electrical Characteristics(Ta=25°C)

参数 Parameter	符号 Symbol	测试条件 Test Conditions	最小值 Min	典型值 Typ	最大值 Max	单位 Unit
Line regulation	V_o	$T_j=25^\circ\text{C}$	-4.8	-5.0	-5.2	V
		$V_i=8\text{ to }20\text{V}$, $I_o=-5\text{mA to }-1\text{A}$, $P_o\leq 15\text{W}$	-4.75	-5.0	-5.25	
Load Regulation	ΔV_o	$T_j=25^\circ\text{C}$ $I_o=5\text{mA to }1.5\text{A}$			100	mV
		$T_j=25^\circ\text{C}$ $I_o=250\text{mA to }750\text{mA}$			50	
Load Regulation	ΔV_o	$T_j=25^\circ\text{C}$ $V_i=-7\text{V to }-25\text{V}$			100	mV
		$T_j=25^\circ\text{C}$ $V_i=-8\text{V to }-12\text{V}$			50	
Bias current	I_d	$T_j=25^\circ\text{C}$			8.0	mA
Bias current change	ΔI_d	$V_i=-8\text{V to }-25\text{V}$			0.8	mA
		$I_o=5\text{mA to }1\text{A}$			0.5	mA
Ratio of Change in VREF to Cathode Voltage	$\Delta V_o/\Delta T$	$I_o=5\text{mA}$		-0.4		mV/°C
RMS Noise vs. %of VOUT	eN	B=10Hz to 100KHz $T_j=25^\circ\text{C}$		100		μV
Ripple Rejection	SVR	$\Delta V_i=10\text{V}$ $f=120\text{Hz}$	54	60		dB
Dropout voltage	V_d	$I_o=1\text{A}$ $T_j=25^\circ\text{C}$ $\Delta V_o=100\text{mV}$		1.4		V
Short Circuit Current Limit	Isc			2.1		A

电参数曲线图 / Electrical Characteristic Curve

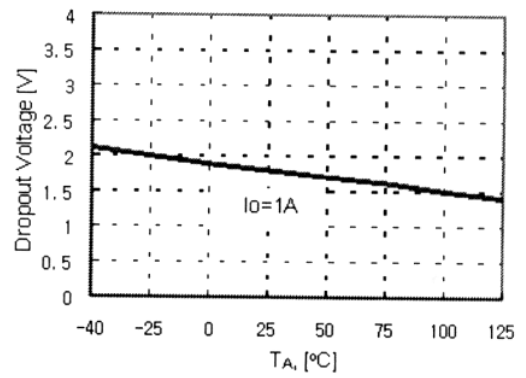
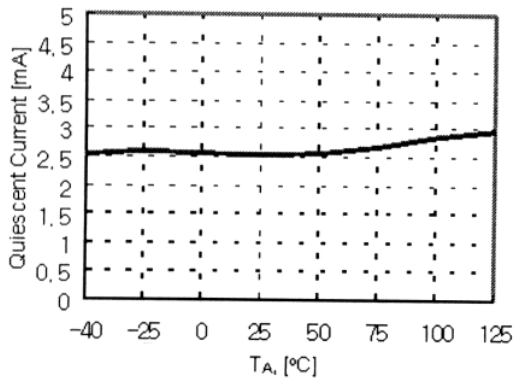
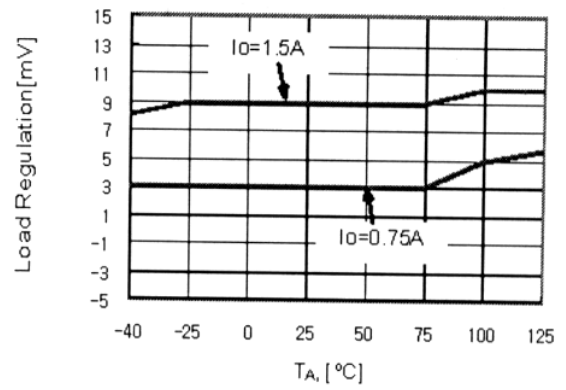
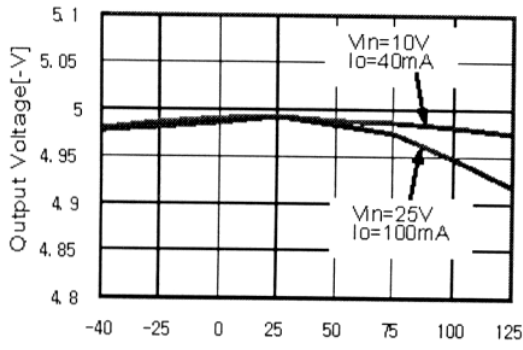

外形尺寸图 / Package Dimensions

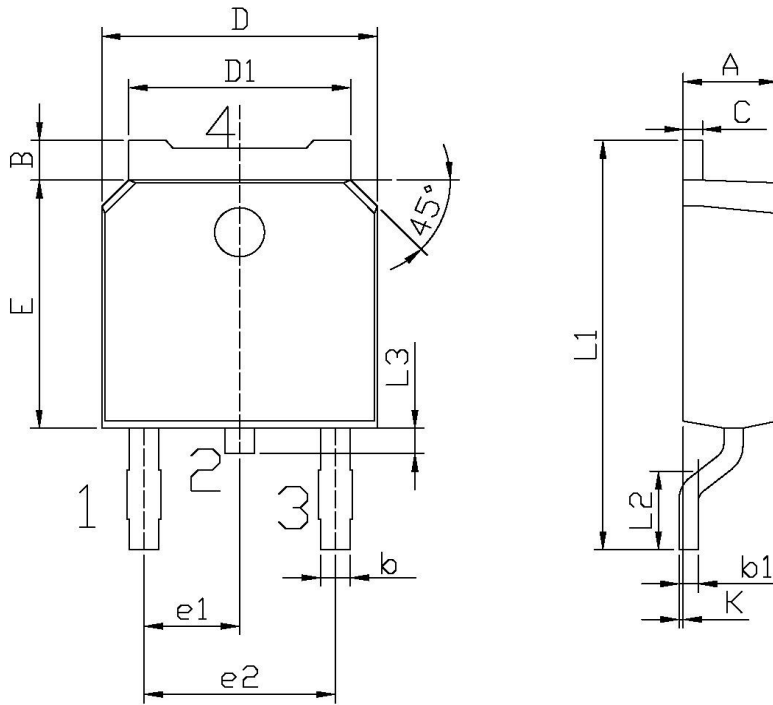

单位: mm

Symbol	Dimensions In Millimeters		Symbol	Dimensions In Millimeters	
	Min	Max		Min	Max
A	2.20	2.40	E	5.95	6.25
B	0.95	1.25	e1	2.24	2.34
b	0.70	0.90	e2	4.43	4.73
b1	0.45	0.55	L1	9.85	10.35
C	0.45	0.55	L2	1.70	2.00
D	6.45	6.75	L3	0.60	0.90
D1	5.10	5.50	K	0.00	0.10

TO-252

印章说明 / Marking Instructions

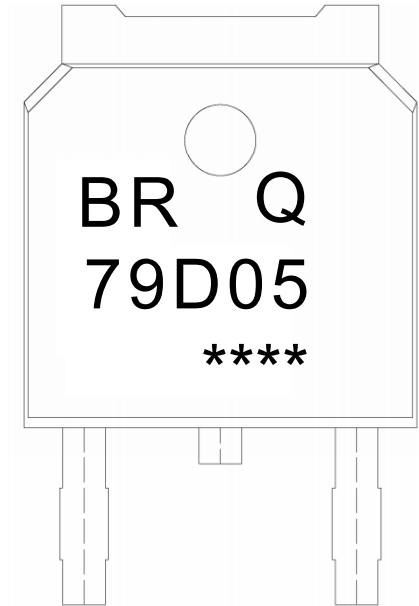

说明：

- BR： 为公司代码
- Q： 为汽车无卤产品标识
- 79D05： 为产品型号
- ****： 为生产批号代码，随生产批号变化

Note:

- BR: Company Code
- Q: Automobile halogen-free product Code
- 79D05: Product Type
- ****: Lot No. Code, code change with Lot No

回流焊温度曲线图(无铅) / Temperature Profile for IR Reflow Soldering(Pb-Free)

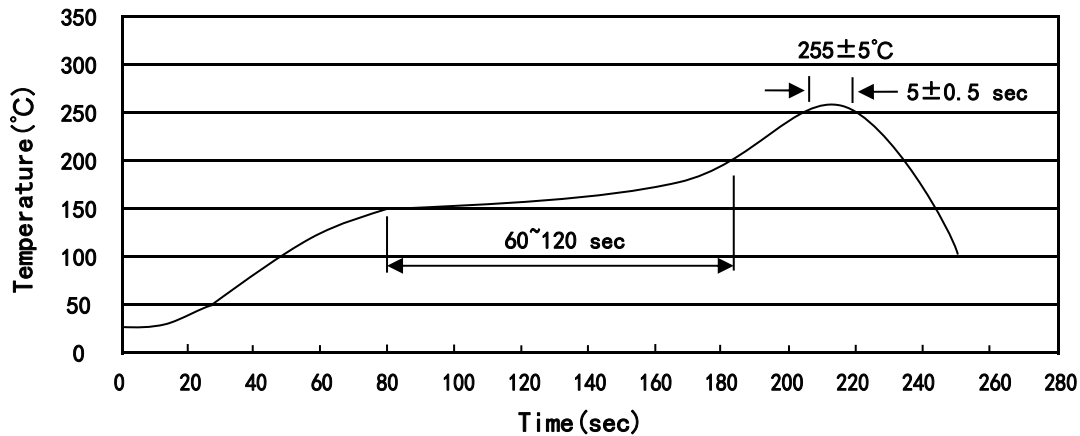

说明：

- 1、预热温度 150~200°C，时间 60~120sec;
- 2、峰值温度 255±5°C，时间持续为 5±0.5sec;
- 3、焊接制程冷却速度为 2~10°C/sec.

Note:

- 1.Preheating:150~200°C, Time:60~120sec.
- 2.Peak Temp.:255±5°C, Duration:5±0.5sec.
3. Cooling Speed: 2~10°C/sec.

耐焊接热试验条件 / Resistance to Soldering Heat Test Conditions

温度：260±5°C 时间：10±1 sec. Temp.:260±5°C Time:10±1 sec

包装规格 / Packaging SPEC.

卷盘包装 / REEL

Package Type 封装形式	Units 包装数量					Dimension 包装尺寸 (unit: mm ³)		
	Units/Reel 只/卷盘	Reels/Inner Box 卷盘/盒	Units/Inner Box 只/盒	Inner Boxes/Outer Box 盒/箱	Units/Outer Box 只/箱	Reel	Inner Box 盒	Outer Box 箱
TO-252	2,500	2	5,000	6	30,000	13" ×16	360×360×50	380×335×366

套管包装 / TUBE

Package Type 封装形式	Units 包装数量					Dimension 包装尺寸 (unit: mm ³)		
	Units/Tube 只/套管	Tubes/Inner Box 套管/盒	Units/Inner Box 只/盒	Inner Boxes/Outer Box 盒/箱	Units/Outer Box 只/箱	Tube 套管	Inner Box 盒	Outer Box 箱
TO-251/252	75	48	3,600	5	18,000	526×20.5×5.25	555×164×50	575×290×180

使用说明 / Notices